

NEW

0.3 mm Pitch, 0.9 mm above the board, Top and bottom Contact, Back-Flip actuator Flexible Printed Circuit ZIF Connectors

FH35 Series



● Small size (35 pos. shown)

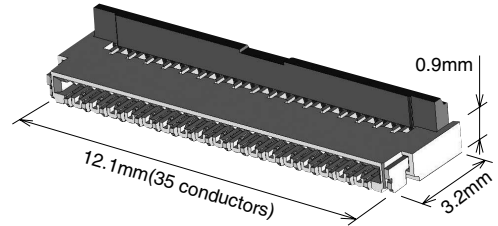

■ Features

1. Low-profile

With the 0.9 mm above the board and width of 3.2 mm the connectors are used in a space saving applications.

2. Unique Back-Flip rotating actuator

The rotating actuator opens from the back of the connector, assuring reliable electrical and mechanical connection.

3. Delivered with the actuator open

FPC can be immediately inserted without the need for the opening of the actuator.

4. Easy FPC insertion

Entry chamfers at all sides of the FPC insertion slot assure correct insertion and positioning of the FPC.

5. Accepts standard FPC thickness

0.2mm thick standard Flexible Printed Circuit (FPC) can be used. This is the only ultra-low profile ZIF connector using standard FPC.

6. Conductive traces on the PCB can run under the connector

No exposed contacts on the bottom of the connector.

7. Board placement with automatic equipment

Flat upper surface and tape and reel packaging facilitate vacuum pick-up and placement. Standard reel packaging contains 5000 connectors.

8. Halogen-free *

(FH35J, FH35RW, FH35W series)

*As defined by IEC61249-2-21

Br-900ppm maximum, Cl-900ppm maximum,
Cl + Br combined-1,500ppm maximum

9. Optional 500 piece reel packaging

Standard packaging is 5,000 pieces per reel; however, 500 piece reels are possible.

(Emboss reel external diameter is 180mm.)

● Easy FPC insertion

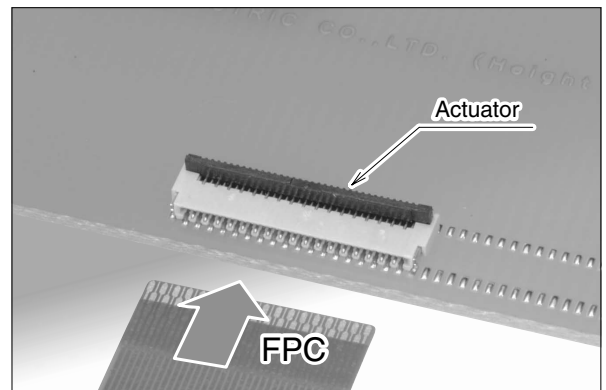

● Completely locked

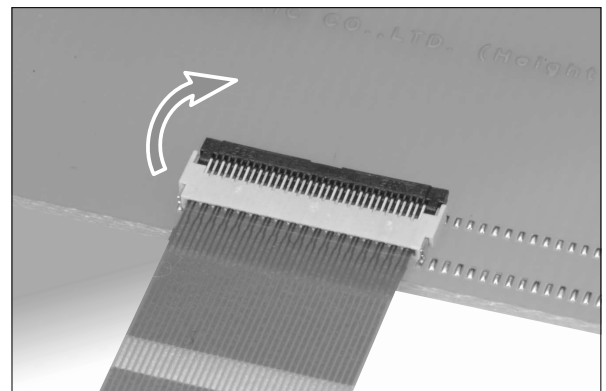

■ Specifications

Rating	Current rating	0.2 A (Note 1)	Operating temperature range	-55 to +85°C (Note 2)	Storage temperature range	-10 to +50°C (Note 3)
	Voltage rating	30 Vrms AC	Operating humidity range	Relative humidity 90% max. (No condensation)	Storage humidity range	Relative humidity 90% max. (No condensation)

Recommended FPC	Thickness: 0.2±0.03, gold plated contact pads
-----------------	---

Item	Specification	Conditions
1. Insulation resistance	50 MΩ min	100 V DC
2. Withstanding voltage	No flashover or insulation breakdown	90 Vrms AC / one minute
3. Contact resistance	100 mΩ max. * Including FPC conductor resistance	1 mA AC
4. Durability	Contact resistance: 100 mΩ max. No damage, cracks, or parts dislocation	10 cycles
5. Vibration	No electrical discontinuity of 1 μs or longer Contact resistance: 100 mΩ max. No damage, cracks, or parts dislocation	Frequency: 10 to 55 Hz, single amplitude of 0.75 mm, 10 cycles in each of the 3 axial directions
6. Shock	No electrical discontinuity of 1 μs or longer Contact resistance: 100 mΩ max. No damage, cracks, or parts dislocation	Acceleration: 981 m/s ² , 6 ms duration, sine half-wave, 3 cycles in each of the 3 axis
7. Humidity (Steady state)	Contact resistance: 100 mΩ max. Insulation resistance: 50 MΩ min. No damage, cracks, or parts looseness	96 hours at 40°C and humidity of 90 to 95%
8. Temperature cycle	Contact resistance: 100 mΩ max. Insulation resistance: 50 MΩ min. No damage, cracks, or parts dislocation	Temperature: -55°C → +15°C to +35°C → +85°C → +15°C to +35°C Time: 30 → 2 to 3 → 30 → 2 to 3 minutes 5 cycles
9. Resistance to soldering heat	No deformation of components affecting performance	Reflow: At the recommended temperature profile Manual soldering: 350 ±10°C for 5 seconds

Note 1: When passing the current through all of the contacts, use 70% of the rated current.

Note 2: Includes temperature rise caused by current flow.

Note 3: The term "storage" refers to products stored for a long period prior to mounting and use.

The operating temperature and humidity range covers the non-conducting condition of connectors after board mounting.

Note 4: Information contained in this catalog represents general requirements for this Series. Contact us for the drawings and specifications for a specific part number shown.

■ Materials

Part	Material	Finish	Remarks	
Insulator	LCP	FH35 series	Color:Beige	UL94V-0
		FH35B series		
		FH35J series		
		FH35W series		
		FH35R series		
	FH35RW series	Color:Gray	UL94V-0	
	FH35 series			
	FH35B series			
	FH35J series			
	FH35R series			
FH35RW series	Color:Light brown	UL94HB		
FH35W series				
Contacts	Phosphor bronze	Gold plating with nickel barrier	——	
Metal fittings	Phosphor bronze	Pure tin reflow plating	——	

■ Ordering information

FH 35 B - 35S - 0.3 SHW (50)

① ② ③ ④ ⑤ ⑥ ⑦

① Series name : FH	④ Number of positions : 15 to 51
② Series No. : 35	⑤ Contact pitch : 0.3 mm
③ Blank:Top contact B:Top contact,Short actuator J:Top contact,Halogen free (Flame retardance UL94V-0). W:Top contact,Halogen free (Flame retardance UL94VHB). R:Bottom contact RW:Bottom contact,Halogen free (Flame retardance UL94VHB).	⑥ Contact type SH : SMT horizontal staggered mounting
	⑦ Specifications: (50) : Nickel barrier gold plating 5,000 pieces / reel (99) : Nickel barrier gold plating 500 pieces / reel

Connector Dimensions

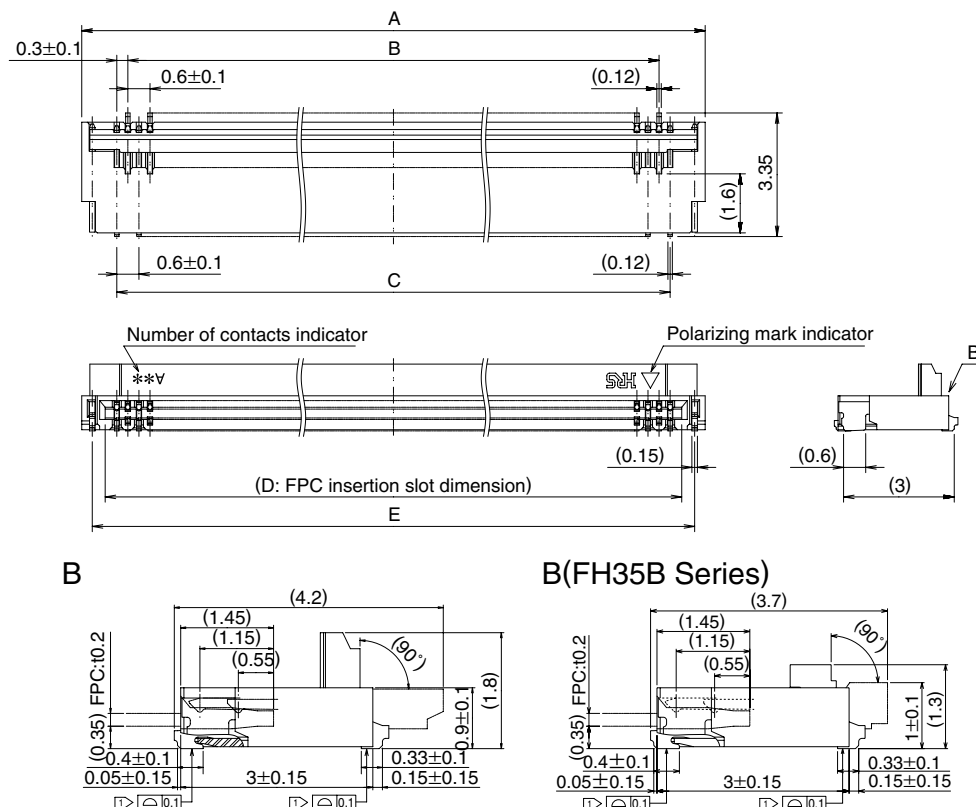

Note 1: The coplanarity of each terminal lead within specified dimension is 0.1 mm Max.

Note 2: Packaged on tape and reel only. Check packaging specification.

Note 3: Slight variations in color of the plastic compounds do not affect form, fit or function of the connector.

Note 4: After reflow, the terminal plating may change color, however this does not represent a quality issue. All dimensions: mm

Part Number	CL No.	Number of contacts	A	B	C	D	E
FH35-19S-0.3SHW(**)	580-1502-3-**	19	7.3	4.8	5.4	6.03	6.73
FH35-25S-0.3SHW(**)	580-1504-9-**	25	9.1	6.6	7.2	7.83	8.53
FH35-27S-0.3SHW(**)	580-1515-5-**	27	9.7	7.2	7.8	8.43	9.13
FH35-31S-0.3SHW(**)	580-1514-2-**	31	10.9	8.4	9	9.63	10.33
FH35-33S-0.3SHW(**)	580-1503-6-**	33	11.5	9	9.6	10.23	10.93
FH35-35S-0.3SHW(**)	580-1501-0-**	35	12.1	9.6	10.2	10.83	11.53
FH35-39S-0.3SHW(**)	580-1512-7-**	39	13.3	10.8	11.4	12.03	12.73
FH35-41S-0.3SHW(**)	580-1520-5-**	41	13.9	11.4	12	12.63	13.33
FH35-45S-0.3SHW(**)	580-1505-1-**	45	15.1	12.6	13.2	13.83	14.53
FH35-49S-0.3SHW(**)	580-1513-0-**	49	16.3	13.8	14.4	15.03	15.73
FH35-51S-0.3SHW(**)	580-1506-4-**	51	16.9	14.4	15	15.63	16.33
FH35B-15S-0.3SHW(**)	580-1524-6-**	15	6.1	3.6	4.2	4.83	5.53
FH35B-19S-0.3SHW(**)	580-1507-7-**	19	7.3	4.8	5.4	6.03	6.73
FH35B-25S-0.3SHW(**)	580-1509-2-**	25	9.1	6.6	7.2	7.83	8.53
FH35B-27S-0.3SHW(**)	580-1510-1-**	27	9.7	7.2	7.8	8.43	9.13
FH35J-25S-0.3SHW(**)	580-1525-9-**	25	9.1	6.6	7.2	7.83	8.53
FH35R-41S-0.3SHW(**)	580-2904-2-**	41	13.9	11.4	12	12.63	13.33
FH35R-51S-0.3SHW(**)	580-2905-5-**	51	16.9	14.4	15	15.63	16.33
FH35RW-21S-0.3SHW(**)	580-2903-0-**	21	7.9	5.4	6	6.63	7.33
FH35RW-25S-0.3SHW(**)	580-2902-7-**	25	9.1	6.6	7.2	7.83	8.53
FH35W-11S-0.3SHW(**)	580-1521-8-**	11	4.9	2.4	3	3.63	4.33
FH35W-21S-0.3SHW(**)	580-1522-0-**	21	7.9	5.4	6	6.63	7.33
FH35W-25S-0.3SHW(**)	580-1508-0-**	25	9.1	6.6	7.2	7.83	8.53
FH35W-31S-0.3SHW(**)	580-1511-4-**	31	10.9	8.4	9	9.63	10.33
FH35W-35S-0.3SHW(**)	580-1526-1-**	35	12.1	9.6	10.2	10.83	11.53
FH35W-51S-0.3SHW(**)	580-1516-8-**	51	16.9	14.4	15	15.63	16.33

Tape and reel packaging (5,000 pieces/reel).

Order by number of reels.

Recommended PCB mounting pattern and metal mask dimensions

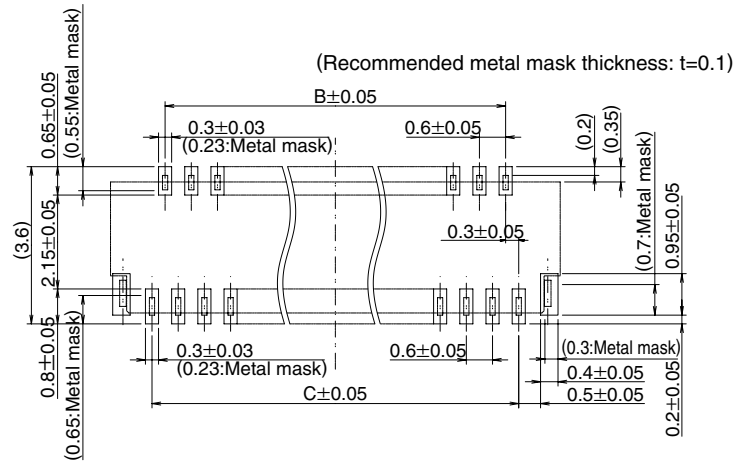

Recommended FPC Dimensions

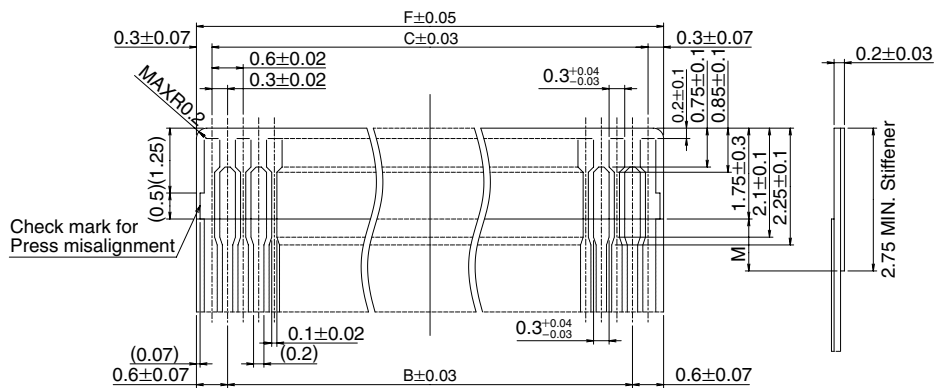

※ Stiffener dimension should be 2.75mm min., and M dimension should be 0.5mm for improved flexibility of FPC.

All dimensions: mm

Part Number	CL No.	Number of contacts	B	C	F
FH35-19S-0.3SHW(**)	580-1502-3-**-	19	4.8	5.4	6
FH35-25S-0.3SHW(**)	580-1504-9-**-	25	6.6	7.2	7.8
FH35-27S-0.3SHW(**)	580-1515-5-**-	27	7.2	7.8	8.4
FH35-31S-0.3SHW(**)	580-1514-2-**-	31	8.4	9	9.6
FH35-33S-0.3SHW(**)	580-1503-6-**-	33	9	9.6	10.2
FH35-35S-0.3SHW(**)	580-1501-0-**-	35	9.6	10.2	10.8
FH35-39S-0.3SHW(**)	580-1512-7-**-	39	10.8	11.4	12
FH35-41S-0.3SHW(**)	580-1520-5-**-	41	11.4	12	12.6
FH35-45S-0.3SHW(**)	580-1505-1-**-	45	12.6	13.2	13.8
FH35-49S-0.3SHW(**)	580-1513-0-**-	49	13.8	14.4	15
FH35-51S-0.3SHW(**)	580-1506-4-**-	51	14.4	15	15.6
FH35B-15S-0.3SHW(**)	580-1524-6-**-	15	3.6	4.2	4.8
FH35B-19S-0.3SHW(**)	580-1507-7-**-	19	4.8	5.4	6
FH35B-25S-0.3SHW(**)	580-1509-2-**-	25	6.6	7.2	7.8
FH35B-27S-0.3SHW(**)	580-1510-1-**-	27	7.2	7.8	8.4
FH35J-25S-0.3SHW(**)	580-1525-9-**-	25	6.6	7.2	7.8
FH35R-41S-0.3SHW(**)	580-2904-2-**-	41	11.4	12	12.6
FH35R-51S-0.3SHW(**)	580-2905-5-**-	51	14.4	15	15.6
FH35RW-21S-0.3SHW(**)	580-2903-0-**-	21	5.4	6	6.6
FH35RW-25S-0.3SHW(**)	580-2902-7-**-	25	6.6	7.2	7.8
FH35W-11S-0.3SHW(**)	580-1521-8-**-	11	2.4	3	3.6
FH35W-21S-0.3SHW(**)	580-1522-0-**-	21	5.4	6	6.6
FH35W-25S-0.3SHW(**)	580-1508-0-**-	25	6.6	7.2	7.8
FH35W-31S-0.3SHW(**)	580-1511-4-**-	31	8.4	9	9.6
FH35W-35S-0.3SHW(**)	580-1526-1-**-	35	9.6	10.2	10.8
FH35W-51S-0.3SHW(**)	580-1516-8-**-	51	14.4	15	15.6

■ Recommended FPC construction

● Contact FPC manufacturer for specific details

1. Using Single-sided FPC

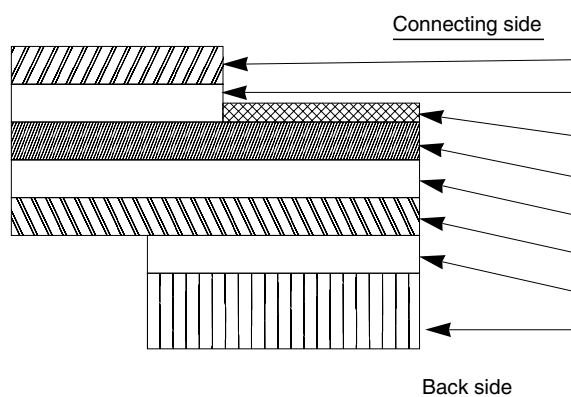

FPC : Flexible Printed Circuit

Material Name	Material	Material Thickness (μm)
Covering film layer	Polyimide 1 mil thick.	(25)
Cover adhesive		(25)
Surface treatment	0.2μm thick gold plated over 1 to 5μm nickel underplating	3
Copper foil	Cu 1oz	35
Base adhesive	Thermosetting adhesive	25
Base film	Polyimide 1 mil thick	25
Reinforcement material adhesive	Thermosetting adhesive	40
Stiffener	Polyimide 3 mil thick	75
Total		203

2. Using Double-sided FPC

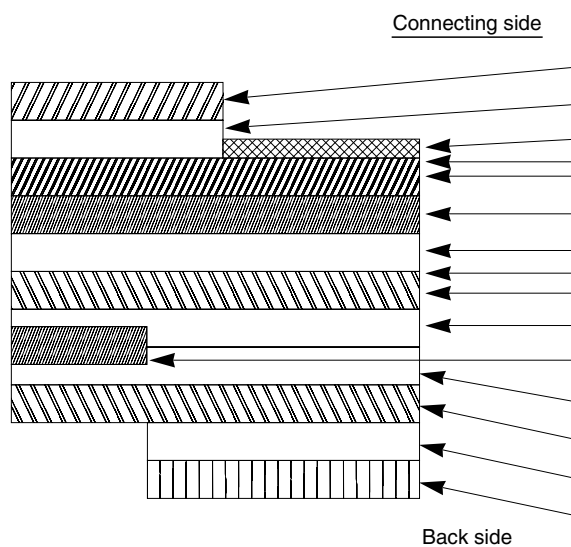

FPC : Flexible Printed Circuit

Material Name	Material	Material Thickness (μm)
Covering layer film	Polyimide 1 mil thick	(25)
Cover adhesive		(25)
Surface treatment	0.2μm thick gold plated over 1 to 5μm nickel underplating	3
Through-hole copper	Cu	15
Copper foil	Cu 1/2oz	18
Base adhesive	Thermosetting adhesive	18
Base film	Polyimide 1 mil thick	25
Base adhesive	Thermosetting adhesive	18
Copper foil	Cu 1/2oz	(18)
Cover adhesive	Thermosetting adhesive	25
Covering film layer	Polyimide 1 mil thick	25
Reinforcement material adhesive	Thermosetting adhesive	25
Stiffener	Polyimide 1 mil thick	25
Total		197

* To prevent release of the FPC due to its bending, use of the double sided FPC with copper foil on the back side is NOT RECOMMENDED.

3. Precautions

1. This specification is a recommendation for the construction of the FH35 Series FPC ($t=0.2 \pm 0.03$).
2. For details about the construction, please contact the FPC/FFC manufacturers.

■ Packaging Specification

● Embossed Carrier Tape Dimensions (Tape width to 24mm max.)

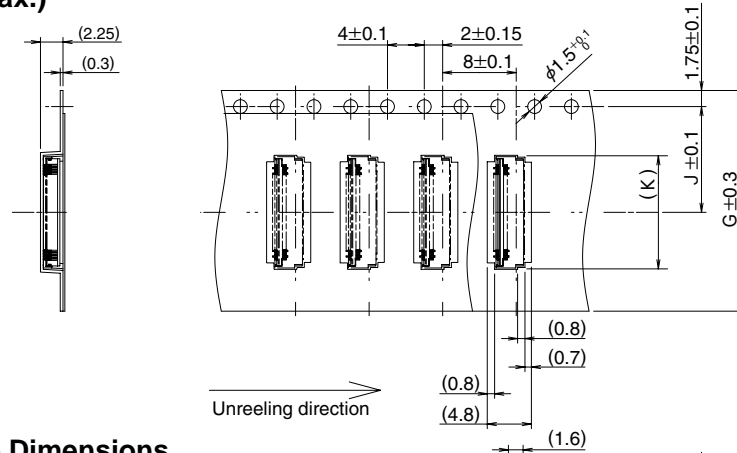

● Embossed Carrier Tape Dimensions (Tape width 32mm min.)

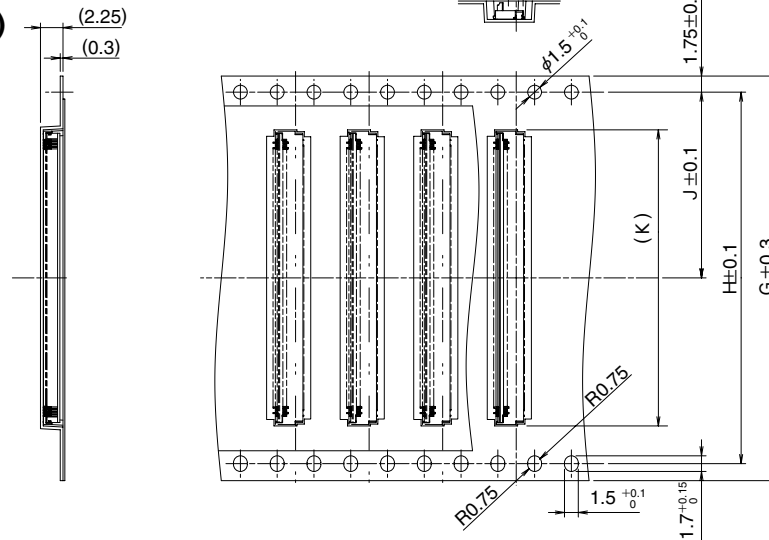

■ Reel Dimensions

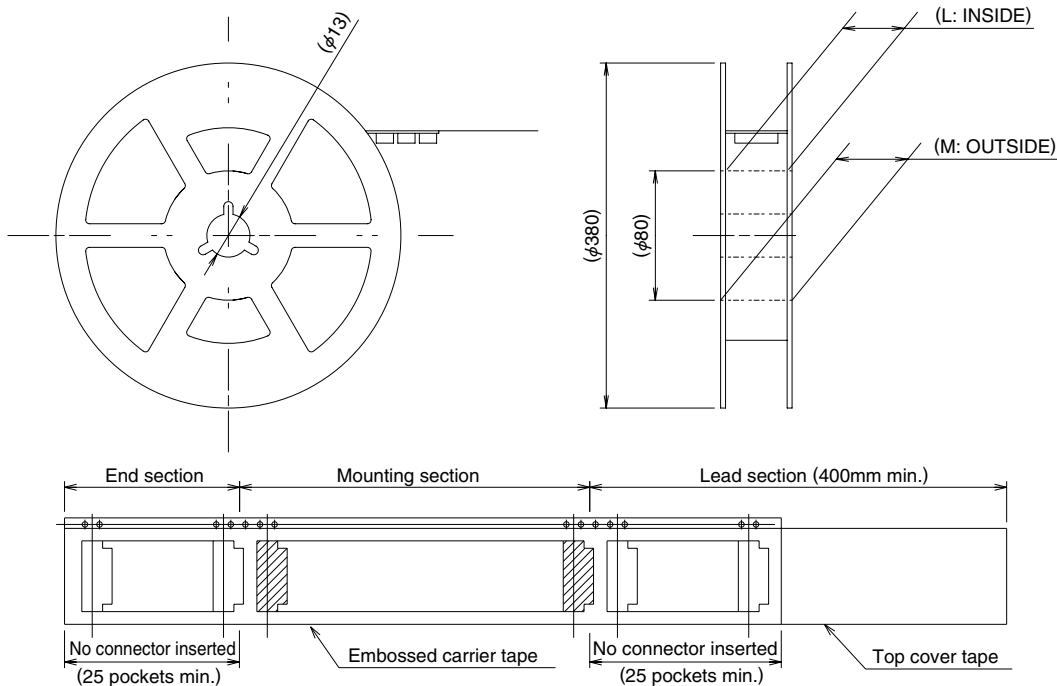

All dimensions: mm

Part Number	CL No.	Number of contacts	G	H	J	K	L	M
FH35-19S-0.3SHW(**)	580-1502-3-**-	19	16	—	7.5	7.5	17.4	21.4
FH35-25S-0.3SHW(**)	580-1504-9-**-	25	24	—	11.5	9.3	25.4	29.4
FH35-27S-0.3SHW(**)	580-1515-5-**-	27	24	—	11.5	9.9	25.4	29.4
FH35-31S-0.3SHW(**)	580-1514-2-**-	31	24	—	11.5	11.1	25.4	29.4
FH35-33S-0.3SHW(**)	580-1503-6-**-	33	24	—	11.5	11.7	25.4	29.4
FH35-35S-0.3SHW(**)	580-1501-0-**-	35	24	—	11.5	12.4	25.4	29.4
FH35-39S-0.3SHW(**)	580-1512-7-**-	39	24	—	11.5	13.5	25.4	29.4
FH35-41S-0.3SHW(**)	580-1520-5-**-	41	24	—	11.5	14.1	25.4	29.4
FH35-45S-0.3SHW(**)	580-1505-1-**-	45	24	—	11.5	15.3	25.4	29.4
FH35-49S-0.3SHW(**)	580-1513-0-**-	49	32	28.4	14.2	16.5	33.4	37.4
FH35-51S-0.3SHW(**)	580-1506-4-**-	51	32	28.4	14.2	17.1	33.4	37.4
FH35B-15S-0.3SHW(**)	580-1524-6-**-	15	16	—	7.5	6.3	17.4	21.4
FH35B-19S-0.3SHW(**)	580-1507-7-**-	19	16	—	7.5	7.5	17.4	21.4
FH35B-25S-0.3SHW(**)	580-1509-2-**-	25	24	—	11.5	9.3	25.4	29.4
FH35B-27S-0.3SHW(**)	580-1510-1-**-	27	24	—	11.5	9.9	25.4	29.4
FH35J-25S-0.3SHW(**)	580-1525-9-**-	25	24	—	11.5	9.3	25.4	29.4
FH35R-41S-0.3SHW(**)	580-2904-2-**-	41	24	—	11.5	14.1	25.4	29.4
FH35R-51S-0.3SHW(**)	580-2905-5-**-	51	32	28.4	14.2	17.1	33.4	37.4
FH35RW-21S-0.3SHW(**)	580-2903-0-**-	21	24	—	11.5	8.1	25.4	29.4
FH35RW-25S-0.3SHW(**)	580-2902-7-**-	25	24	—	11.5	9.3	25.4	29.4
FH35W-11S-0.3SHW(**)	580-1521-8-**-	11	16	—	7.5	5.1	17.4	21.4
FH35W-21S-0.3SHW(**)	580-1522-0-**-	21	24	—	11.5	8.1	25.4	29.4
FH35W-25S-0.3SHW(**)	580-1508-0-**-	25	24	—	11.5	9.3	25.4	29.4
FH35W-31S-0.3SHW(**)	580-1511-4-**-	31	24	—	11.5	11.1	25.4	29.4
FH35W-35S-0.3SHW(**)	580-1526-1-**-	35	24	—	11.5	12.4	25.4	29.4
FH35W-51S-0.3SHW(**)	580-1516-8-**-	51	32	28.4	14.2	17.1	33.4	37.4

Tape and reel packaging (5,000 pieces/reel).

Note 1: Reserved for future product expansion. Contact HRS for details on availability.

■ Temperature Profile

● Using Lead-free Solder Paste

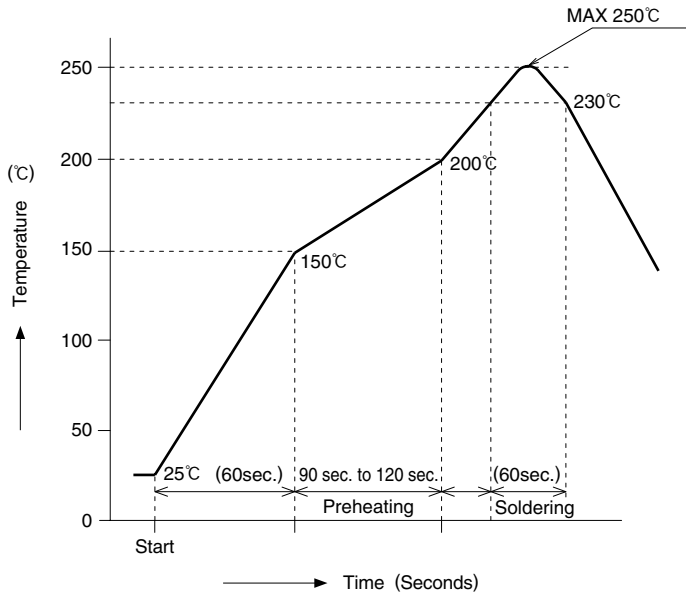

HRS test condition

Solder method :Reflow, IR/hot air
Environment :Room air
Solder composition :Paste, 96.5%Sn/3.0%Ag/0.5%Cu
(Senju Metal Industry, Co., Ltd.'s
Part Number:M705-221CM5-32-10.5)
Test board :Glass epoxy 25mm×50mm×0.8mm thick
Land dimensions :0.3mm×0.65mm, 0.3mm×0.8mm
Metal mask :0.23×0.55, 0.23×0.65×0.1mm thick

The temperature profiles shown are based on the above conditions.

In individual applications the actual temperature may vary, depending on solder paste type, volume / thickness and board size / thickness. Consult your solder paste and equipment manufacturer for specific recommendations.

■ Connector Operation and Precautions

Operation

Exercise care when handling connectors. Follow recommendations given below.

1. As delivered

- ① Delivered with the actuator open. There is no need to operate the actuator prior to the insertion of the FPC.

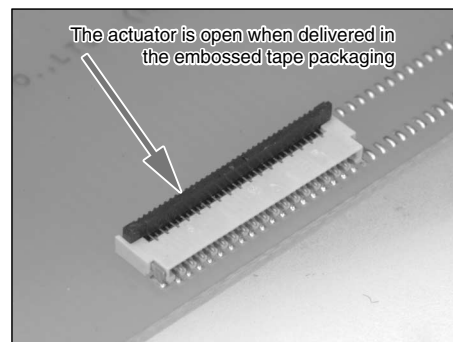

2. FPC insertion (Top contact)

- ① Make sure that the conductive pads are facing up.
- ② Align the FPC perpendicular with the connector and insert it firmly all the way.

*For the bottom contact, reverse.

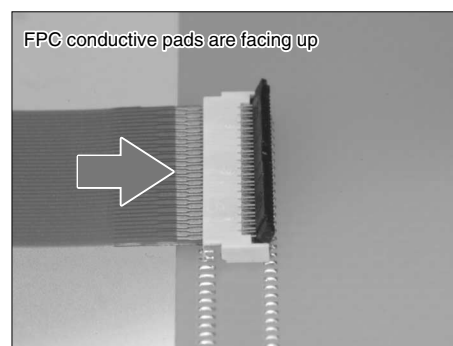

3. FPC correct insertion verification (Top contact)

A visual comparison of the edge of the housing opening and the FPC pattern boundary will prevent diagonal insertion and partial insertion errors.

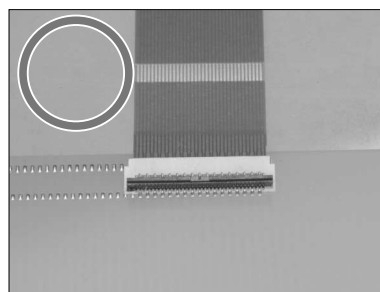
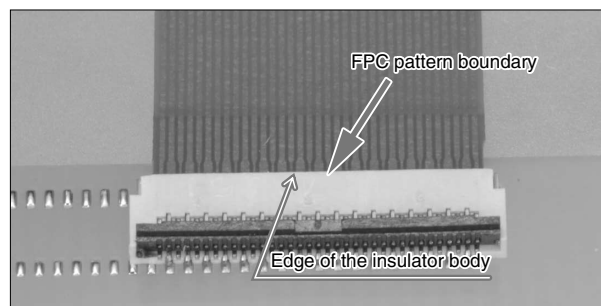

Correct insertion

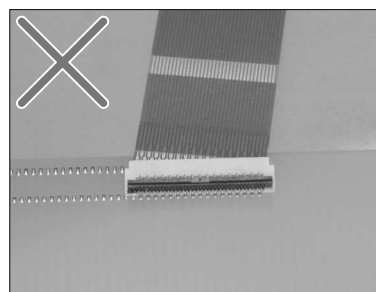

Diagonal insertion

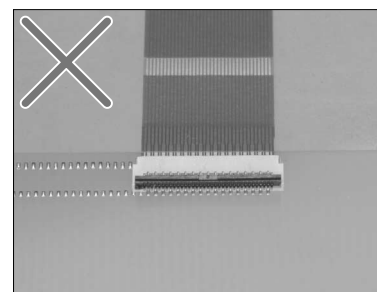

Partial insertion

Operation

4. Locking

- 1 After FPC/FFC insertion, rotate the actuator down to a full stop, pushing it at the center.

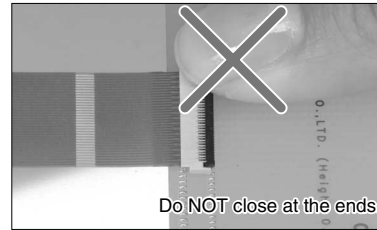
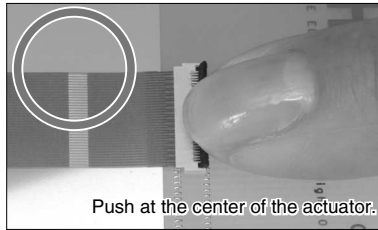
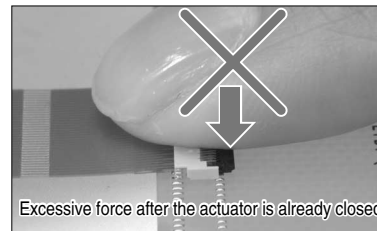
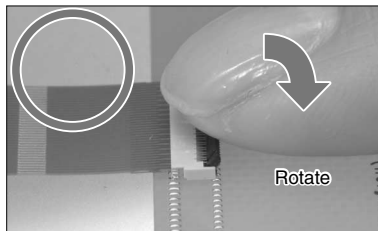

5. FPC removal (Lock release)

Carefully rotate the actuator up to 90°, lifting it at the center.

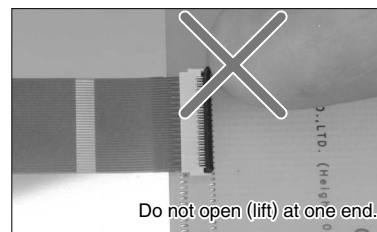
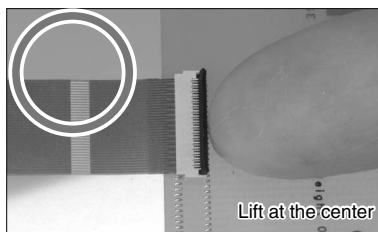
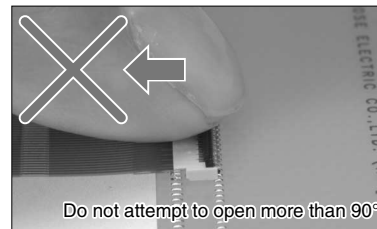
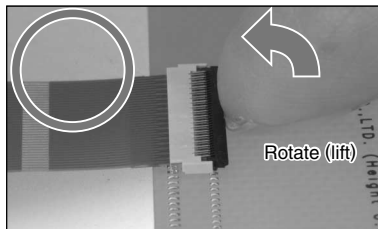

* The actuator opens by rotating it in the direction OPPOSITE to the direction of the insertion of the FPC.
DO NOT attempt to open it from the same side as the insertion of the FPC.

Precautions when mounting connectors on the PCB

◆ Handling before mounting on PCB

Insertion of the FPC or operation of the actuator prior to mounting on the PCB is NOT RECOMMENDED.

◆ PC board warpage

Minimize the warpage as much as possible. The connector is straight within 0.1 mm max. Make sure that the mounting area flatness can accept the connector terminals without causing any failure of the solder joints.

◆ Forces on the board

◆ When braking the large PC board into individual boards exercise care NOT to damage the installed connectors.

◆ When attaching the boards or other components with the screws make sure that any stresses will NOT cause board deflections affecting the mounting areas of the connector

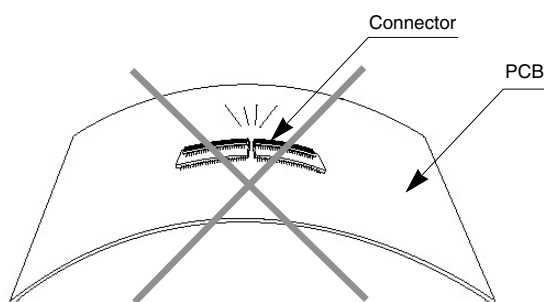

Other precautions

◆ When hand soldering:

Do not perform hand soldering with the FPC inserted in the connector.

- Do not apply excessive heat or touch the soldering iron anywhere other than the connector leads.
- Do not use excessive amount of solder or flux compounds.

Operation of the actuator or contacts may be affected by excessive amounts of solder or flux compounds.