



## Miniature Basic Switch

# Miniature Basic Switch that Offers High Reliability and Security

- Wide variation of best-selling microswitches with switching currents of 10 to 21 A.
- Can be used for interrupting current when doors are opened or closed.
- Available in two types of cases: thermoplastic resin and thermosetting resin.

RoHS Compliant

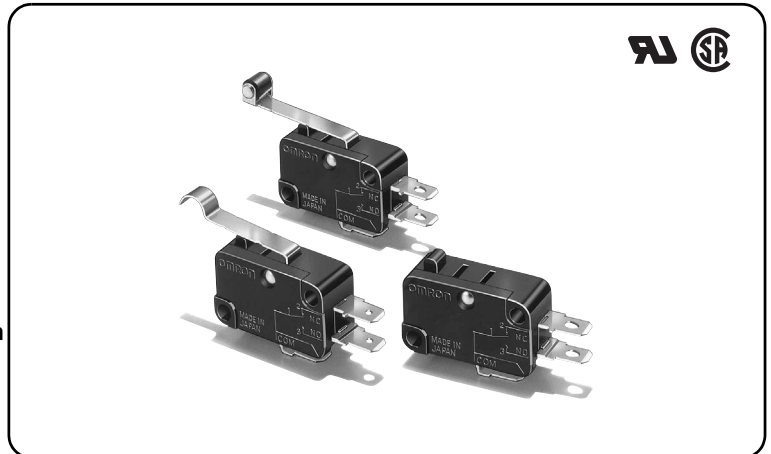

## Model Number Legend

V- 1 2 - 3 4 5 6

### 1. Ratings

- 21: 21 A at 250 VAC
- 16: 16 A at 250 VAC
- 15: 15 A at 250 VAC
- 10: 10 A at 250 VAC

### 2. Actuator

- None : Pin plunger
- 1 : Short hinge lever
- 2 : Hinge lever
- 3 : Long hinge lever
- 4 : Simulated roller lever
- 5 : Short hinge roller lever
- 6 : Hinge roller lever

### 3. Contact Form

- 1: SPDT
- 2: SPST-NC
- 3: SPST-NO

### 4. Terminals

- A : Solder terminals
- C2 : Quick-connect terminals (#187)
- C : Quick-connect terminals (#250)

### 5. Maximum Operating Force

- 6: 3.92 N {400 gf}
  - 5: 1.96 N {200 gf}
  - 4: 0.98 N {100 gf}
- Note: These values are for the pin plunger models.

### 6. Heat Resistance



- None : Standard (80°C)
- T : Heat-resistive (150°C)

## List of Models

### Thermoplastic Case



Actuator	Terminals	Contact form	Maximum operating force (OF)	Ratings	
				21A	16A
Pin plunger 	Solder terminals (A)	SPDT	3.92N	---	<b>V-16-1A6</b>
		SPST-NC		---	<b>V-16-2A6</b>
		SPST-NO		---	<b>V-16-3A6</b>
		SPDT	1.96N	---	<b>V-16-1A5</b>
		SPST-NC		---	<b>V-16-2A5</b>
		SPST-NO		---	<b>V-16-3A5</b>
		SPDT	0.98N	---	---
		SPST-NC		---	---
		SPST-NO		---	---
	Quick-connect terminals (#187) (C2)	SPDT	3.92N	---	<b>V-16-1C26</b>
		SPST-NC		---	<b>V-16-2C26</b>
		SPST-NO		---	<b>V-16-3C26</b>
		SPDT	1.96N	---	<b>V-16-1C25</b>
		SPST-NC		---	<b>V-16-2C25</b>
		SPST-NO		---	<b>V-16-3C25</b>
		SPDT	0.98N	---	---
		SPST-NC		---	---
		SPST-NO		---	---
	Quick-connect terminals (#250) (C)	SPDT	3.92N	<b>V-21-1C6</b>	<b>V-16-1C6</b>
		SPST-NC		<b>V-21-2C6</b>	<b>V-16-2C6</b>
		SPST-NO		<b>V-21-3C6</b>	<b>V-16-3C6</b>
		SPDT	1.96N	---	<b>V-16-1C5</b>
		SPST-NC		---	<b>V-16-2C5</b>
		SPST-NO		---	<b>V-16-3C5</b>
SPDT		0.98N	---	---	
SPST-NC			---	---	
SPST-NO			---	---	

Refer to "Micro Switch Common Accessories" for Separators (sold separately), Actuators (sold separately) and Terminal Connectors (sold separately).



Actuator	Terminals	Contact form	Ratings		
			Maximum operating force (OF)	21A	16A
Short hinge lever 	Solder terminals (A)	SPDT	3.92N	---	V-161-1A6
		SPST-NC		---	V-161-2A6
		SPST-NO		---	V-161-3A6
		SPDT	1.96N	---	V-161-1A5
		SPST-NC		---	V-161-2A5
		SPST-NO		---	V-161-3A5
		SPDT	0.98N	---	---
		SPST-NC		---	---
		SPST-NO		---	---
	Quick-connect terminals (#187) (C2)	SPDT	3.92N	---	V-161-1C26
		SPST-NC		---	V-161-2C26
		SPST-NO		---	V-161-3C26
		SPDT	1.96N	---	V-161-1C25
		SPST-NC		---	V-161-2C25
		SPST-NO		---	V-161-3C25
		SPDT	0.98N	---	---
		SPST-NC		---	---
		SPST-NO		---	---
	Quick-connect terminals (#250) (C)	SPDT	3.92N	V-211-1C6	V-161-1C6
		SPST-NC		V-211-2C6	V-161-2C6
		SPST-NO		V-211-3C6	V-161-3C6
		SPDT	1.96N	---	V-161-1C5
		SPST-NC		---	V-161-2C5
		SPST-NO		---	V-161-3C5
SPDT		0.98N	---	---	
SPST-NC			---	---	
SPST-NO			---	---	
Hinge lever 	Solder terminals (A)	SPDT	2.45N	---	V-162-1A6
		SPST-NC		---	V-162-2A6
		SPST-NO		---	V-162-3A6
		SPDT	1.23N	---	V-162-1A5
		SPST-NC		---	V-162-2A5
		SPST-NO		---	V-162-3A5
		SPDT	0.59N	---	---
		SPST-NC		---	---
		SPST-NO		---	---
	Quick-connect terminals (#187) (C2)	SPDT	2.45N	---	V-162-1C26
		SPST-NC		---	V-162-2C26
		SPST-NO		---	V-162-3C26
		SPDT	1.23N	---	V-162-1C25
		SPST-NC		---	V-162-2C25
		SPST-NO		---	V-162-3C25
		SPDT	0.59N	---	---
		SPST-NC		---	---
		SPST-NO		---	---
	Quick-connect terminals (#250) (C)	SPDT	2.45N	V-212-1C6	V-162-1C6
		SPST-NC		V-212-2C6	V-162-2C6
		SPST-NO		V-212-3C6	V-162-3C6
		SPDT	1.23N	---	V-162-1C5
		SPST-NC		---	V-162-2C5
		SPST-NO		---	V-162-3C5
SPDT		0.59N	---	---	
SPST-NC			---	---	
SPST-NO			---	---	

V

Refer to "Micro Switch Common Accessories" for Separators (sold separately), Actuators (sold separately) and Terminal Connectors (sold separately).

Actuator	Terminals	Contact form	Maximum operating force (OF)	Ratings	
				21A	16A
Long hinge lever 	Solder terminals (A)	SPDT	1.27N	---	V-163-1A6
		SPST-NC		---	V-163-2A6
		SPST-NO		---	V-163-3A6
		SPDT	0.69N	---	V-163-1A5
		SPST-NC		---	V-163-2A5
		SPST-NO		---	V-163-3A5
		SPDT	0.34N	---	---
		SPST-NC		---	---
		SPST-NO		---	---
	Quick-connect terminals (#187) (C2)	SPDT	1.27N	---	V-163-1C26
		SPST-NC		---	V-163-2C26
		SPST-NO		---	V-163-3C26
		SPDT	0.69N	---	V-163-1C25
		SPST-NC		---	V-163-2C25
		SPST-NO		---	V-163-3C25
		SPDT	0.34N	---	---
		SPST-NC		---	---
		SPST-NO		---	---
	Quick-connect terminals (#250) (C)	SPDT	1.27N	V-213-1C6	V-163-1C6
		SPST-NC		V-213-2C6	V-163-2C6
		SPST-NO		V-213-3C6	V-163-3C6
		SPDT	0.69N	---	V-163-1C5
		SPST-NC		---	V-163-2C5
		SPST-NO		---	V-163-3C5
SPDT		0.34N	---	---	
SPST-NC			---	---	
SPST-NO			---	---	
Simulated roller lever 	Solder terminals (A)	SPDT	2.45N	---	V-164-1A6
		SPST-NC		---	V-164-2A6
		SPST-NO		---	V-164-3A6
		SPDT	1.23N	---	V-164-1A5
		SPST-NC		---	V-164-2A5
		SPST-NO		---	V-164-3A5
		SPDT	0.59N	---	---
		SPST-NC		---	---
		SPST-NO		---	---
	Quick-connect terminals (#187) (C2)	SPDT	2.45N	---	V-164-1C26
		SPST-NC		---	V-164-2C26
		SPST-NO		---	V-164-3C26
		SPDT	1.23N	---	V-164-1C25
		SPST-NC		---	V-164-2C25
		SPST-NO		---	V-164-3C25
		SPDT	0.59N	---	---
		SPST-NC		---	---
		SPST-NO		---	---
	Quick-connect terminals (#250) (C)	SPDT	2.45N	V-214-1C6	V-164-1C6
		SPST-NC		V-214-2C6	V-164-2C6
		SPST-NO		V-214-3C6	V-164-3C6
		SPDT	1.23N	---	V-164-1C5
		SPST-NC		---	V-164-2C5
		SPST-NO		---	V-164-3C5
SPDT		0.59N	---	---	
SPST-NC			---	---	
SPST-NO			---	---	



Refer to "Micro Switch Common Accessories" for Separators (sold separately), Actuators (sold separately) and Terminal Connectors (sold separately).

Actuator	Terminals	Contact form	Ratings		
			Maximum operating force (OF)	21A	16A
Short hinge roller lever 	Solder terminals (A)	SPDT	4.71N	---	V-165-1A6
		SPST-NC		---	V-165-2A6
		SPST-NO		---	V-165-3A6
		SPDT	2.35N	---	V-165-1A5
		SPST-NC		---	V-165-2A5
		SPST-NO		---	V-165-3A5
		SPDT	1.18N	---	---
		SPST-NC		---	---
		SPST-NO		---	---
	Quick-connect terminals (#187) (C2)	SPDT	4.71N	---	V-165-1C26
		SPST-NC		---	V-165-2C26
		SPST-NO		---	V-165-3C26
		SPDT	2.35N	---	V-165-1C25
		SPST-NC		---	V-165-2C25
		SPST-NO		---	V-165-3C25
		SPDT	1.18N	---	---
		SPST-NC		---	---
		SPST-NO		---	---
	Quick-connect terminals (#250) (C)	SPDT	4.71N	V-215-1C6	V-165-1C6
		SPST-NC		V-215-2C6	V-165-2C6
		SPST-NO		V-215-3C6	V-165-3C6
		SPDT	2.35N	---	V-165-1C5
		SPST-NC		---	V-165-2C5
		SPST-NO		---	V-165-3C5
SPDT		1.18N	---	---	
SPST-NC			---	---	
SPST-NO			---	---	
Hinge roller lever 	Solder terminals (A)	SPDT	2.45N	---	V-166-1A6
		SPST-NC		---	V-166-2A6
		SPST-NO		---	V-166-3A6
		SPDT	1.23N	---	V-166-1A5
		SPST-NC		---	V-166-2A5
		SPST-NO		---	V-166-3A5
		SPDT	0.59N	---	---
		SPST-NC		---	---
		SPST-NO		---	---
	Quick-connect terminals (#187) (C2)	SPDT	2.45N	---	V-166-1C26
		SPST-NC		---	V-166-2C26
		SPST-NO		---	V-166-3C26
		SPDT	1.23N	---	V-166-1C25
		SPST-NC		---	V-166-2C25
		SPST-NO		---	V-166-3C25
		SPDT	0.59N	---	---
		SPST-NC		---	---
		SPST-NO		---	---
	Quick-connect terminals (#250) (C)	SPDT	2.45N	V-216-1C6	V-166-1C6
		SPST-NC		V-216-2C6	V-166-2C6
		SPST-NO		V-216-3C6	V-166-3C6
		SPDT	1.23N	---	V-166-1C5
		SPST-NC		---	V-166-2C5
		SPST-NO		---	V-166-3C5
SPDT		0.59N	---	---	
SPST-NC			---	---	
SPST-NO			---	---	



V

Refer to "Micro Switch Common Accessories" for Separators (sold separately), Actuators (sold separately) and Terminal Connectors (sold separately).



Thermosetting case

Actuator	Terminals	Contact form	Maximum operating force (OF)	Ratings	15A	10A	Heat-resistive	
							15A	10A
Pin plunger 	Solder terminals (A)	SPDT	3.92N		V-15-1A6	---	V-15-1A6-T	---
		SPST-NC			V-15-2A6	---	---	---
		SPST-NO			V-15-3A6	---	---	---
		SPDT	1.96N		V-15-1A5	V-10-1A5	V-15-1A5-T	V-10-1A5-T
		SPST-NC			V-15-2A5	V-10-2A5	---	---
		SPST-NO			V-15-3A5	V-10-3A5	---	---
		SPDT	0.98N		---	V-10-1A4	---	V-10-1A4-T
		SPST-NC			---	V-10-2A4	---	V-10-2A4-T
		SPST-NO			---	V-10-3A4	---	V-10-3A4-T
	Quick-connect terminals (#187) (C2)	SPDT	3.92N		V-15-1C26	---	V-15-1C26-T	---
		SPST-NC			V-15-2C26	---	---	---
		SPST-NO			V-15-3C26	---	---	---
		SPDT	1.96N		V-15-1C25	V-10-1C25	V-15-1C25-T	V-10-1C25-T
		SPST-NC			V-15-2C25	V-10-2C25	---	---
		SPST-NO			V-15-3C25	V-10-3C25	---	---
		SPDT	0.98N		---	V-10-1C24	---	V-10-1C24-T
		SPST-NC			---	V-10-2C24	---	---
		SPST-NO			---	V-10-3C24	---	---
	Quick-connect terminals (#250) (C)	SPDT	3.92N		V-15-1C6	---	V-15-1C6-T	---
		SPST-NC			V-15-2C6	---	---	---
		SPST-NO			V-15-3C6	---	---	---
		SPDT	1.96N		V-15-1C5	V-10-1C5	V-15-1C5-T	V-10-1C5-T
		SPST-NC			V-15-2C5	V-10-2C5	---	---
		SPST-NO			V-15-3C5	V-10-3C5	---	---
SPDT		0.98N	---		V-10-1C4	---	V-10-1C4-T	
SPST-NC			---		V-10-2C4	---	---	
SPST-NO			---		V-10-3C4	---	---	
Short hinge lever 	Solder terminals (A)	SPDT	3.92N		V-151-1A6	---	V-151-1A6-T	---
		SPST-NC			V-151-2A6	---	---	---
		SPST-NO			V-151-3A6	---	---	---
		SPDT	1.96N		V-151-1A5	V-101-1A5	V-151-1A5-T	V-101-1A5-T
		SPST-NC			V-151-2A5	V-101-2A5	---	---
		SPST-NO			V-151-3A5	V-101-3A5	---	---
		SPDT	0.98N		---	V-101-1A4	---	V-101-1A4-T
		SPST-NC			---	V-101-2A4	---	---
		SPST-NO			---	V-101-3A4	---	---
	Quick-connect terminals (#187) (C2)	SPDT	3.92N		V-151-1C26	---	V-151-1C26-T	---
		SPST-NC			V-151-2C26	---	---	---
		SPST-NO			V-151-3C26	---	---	---
		SPDT	1.96N		V-151-1C25	V-101-1C25	V-151-1C25-T	V-101-1C25-T
		SPST-NC			V-151-2C25	V-101-2C25	---	---
		SPST-NO			V-151-3C25	V-101-3C25	---	---
		SPDT	0.98N		---	V-101-1C24	---	V-101-1C24-T
		SPST-NC			---	V-101-2C24	---	---
		SPST-NO			---	V-101-3C24	---	---
	Quick-connect terminals (#250) (C)	SPDT	3.92N		V-151-1C6	---	V-151-1C6-T	---
		SPST-NC			V-151-2C6	---	---	---
		SPST-NO			V-151-3C6	---	---	---
		SPDT	1.96N		V-151-1C5	V-101-1C5	V-151-1C5-T	V-101-1C5-T
		SPST-NC			V-151-2C5	V-101-2C5	---	---
		SPST-NO			V-151-3C5	V-101-3C5	---	---
SPDT		0.98N	---		V-101-1C4	---	V-101-1C4-T	
SPST-NC			---		V-101-2C4	---	---	
SPST-NO			---		V-101-3C4	---	---	

Refer to "Micro Switch Common Accessories" for Separators (sold separately), Actuators (sold separately) and Terminal Connectors (sold separately).

Actuator	Terminals	Contact form	Ratings Maximum operating force (OF)	15A	10A	Heat-resistive	
						15A	10A
	Solder terminals (A)	SPDT	2.45N	V-152-1A6	---	V-152-1A6-T	---
		SPST-NC		V-152-2A6	---	---	---
		SPST-NO		V-152-3A6	---	---	
		SPDT	1.23N	V-152-1A5	V-102-1A5	V-152-1A5-T	V-102-1A5-T
		SPST-NC		V-152-2A5	V-102-2A5	---	---
		SPST-NO		V-152-3A5	V-102-3A5	---	---
		SPDT	0.59N	---	V-102-1A4	---	V-102-1A4-T
		SPST-NC		---	V-102-2A4	---	---
		SPST-NO		---	V-102-3A4	---	---
	Quick-connect terminals (#187) (C2)	SPDT	2.45N	V-152-1C26	---	V-152-1C26-T	---
		SPST-NC		V-152-2C26	---	---	---
		SPST-NO		V-152-3C26	---	---	
		SPDT	1.23N	V-152-1C25	V-102-1C25	V-152-1C25-T	V-102-1C25-T
		SPST-NC		V-152-2C25	V-102-2C25	---	---
		SPST-NO		V-152-3C25	V-102-3C25	---	---
		SPDT	0.59N	---	V-102-1C24	---	V-102-1C24-T
		SPST-NC		---	V-102-2C24	---	---
		SPST-NO		---	V-102-3C24	---	---
	Quick-connect terminals (#250) (C)	SPDT	2.45N	V-152-1C6	---	V-152-1C6-T	---
		SPST-NC		V-152-2C6	---	---	
		SPST-NO		V-152-3C6	---	---	
		SPDT	1.23N	V-152-1C5	V-102-1C5	V-152-1C5-T	V-102-1C5-T
		SPST-NC		V-152-2C5	V-102-2C5	---	---
		SPST-NO		V-152-3C5	V-102-3C5	---	---
SPDT		0.59N	---	V-102-1C4	---	V-102-1C4-T	
SPST-NC			---	V-102-2C4	---	---	
SPST-NO			---	V-102-3C4	---	---	
	Solder terminals (A)	SPDT	1.27N	V-153-1A6	---	V-153-1A6-T	---
		SPST-NC		V-153-2A6	---	---	---
		SPST-NO		V-153-3A6	---	---	
		SPDT	0.69N	V-153-1A5	V-103-1A5	V-153-1A5-T	V-103-1A5-T
		SPST-NC		V-153-2A5	V-103-2A5	---	---
		SPST-NO		V-153-3A5	V-103-3A5	---	---
		SPDT	0.34N	---	V-103-1A4	---	V-103-1A4-T
		SPST-NC		---	V-103-2A4	---	---
		SPST-NO		---	V-103-3A4	---	---
	Quick-connect terminals (#187) (C2)	SPDT	1.27N	V-153-1C26	---	V-153-1C26-T	---
		SPST-NC		V-153-2C26	---	---	---
		SPST-NO		V-153-3C26	---	---	
		SPDT	0.69N	V-153-1C25	V-103-1C25	V-153-1C25-T	V-103-1C25-T
		SPST-NC		V-153-2C25	V-103-2C25	---	---
		SPST-NO		V-153-3C25	V-103-3C25	---	---
		SPDT	0.34N	---	V-103-1C24	---	V-103-1C24-T
		SPST-NC		---	V-103-2C24	---	---
		SPST-NO		---	V-103-3C24	---	---
	Quick-connect terminals (#250) (C)	SPDT	1.27N	V-153-1C6	---	V-153-1C6-T	---
		SPST-NC		V-153-2C6	---	---	---
		SPST-NO		V-153-3C6	---	---	
		SPDT	0.69N	V-153-1C5	V-103-1C5	V-153-1C5-T	V-103-1C5-T
		SPST-NC		V-153-2C5	V-103-2C5	---	---
		SPST-NO		V-153-3C5	V-103-3C5	---	---
SPDT		0.34N	---	V-103-1C4	---	V-103-1C4-T	
SPST-NC			---	V-103-2C4	---	---	
SPST-NO			---	V-103-3C4	---	---	

Refer to "Micro Switch Common Accessories" for Separators (sold separately), Actuators (sold separately) and Terminal Connectors (sold separately).

Actuator	Terminals	Contact form	Ratings Maximum operating force (OF)	15A	10A	Heat-resistive	
						15A	10A
Simulated roller lever 	Solder terminals (A)	SPDT	2.45N	V-154-1A6	---	V-154-1A6-T	---
		SPST-NC		V-154-2A6	---	---	---
		SPST-NO		V-154-3A6	---	---	
		SPDT	1.23N	V-154-1A5	V-104-1A5	V-154-1A5-T	V-104-1A5-T
		SPST-NC		V-154-2A5	V-104-2A5	---	---
		SPST-NO		V-154-3A5	V-104-3A5	---	---
		SPDT	0.59N	---	V-104-1A4	---	V-104-1A4-T
		SPST-NC		---	V-104-2A4	---	---
		SPST-NO		---	V-104-3A4	---	---
	Quick-connect terminals (#187) (C2)	SPDT	2.45N	V-154-1C26	---	V-154-1C26-T	---
		SPST-NC		V-154-2C26	---	---	---
		SPST-NO		V-154-3C26	---	---	---
		SPDT	1.23N	V-154-1C25	V-104-1C25	V-154-1C25-T	V-104-1C25-T
		SPST-NC		V-154-2C25	V-104-2C25	---	---
		SPST-NO		V-154-3C25	V-104-3C25	---	---
		SPDT	0.59N	---	V-104-1C24	---	V-104-1C24-T
		SPST-NC		---	V-104-2C24	---	---
		SPST-NO		---	V-104-3C24	---	---
	Quick-connect terminals (#250) (C)	SPDT	2.45N	V-154-1C6	---	V-154-1C6-T	---
		SPST-NC		V-154-2C6	---	---	---
		SPST-NO		V-154-3C6	---	---	---
		SPDT	1.23N	V-154-1C5	V-104-1C5	V-154-1C5-T	V-104-1C5-T
		SPST-NC		V-154-2C5	V-104-2C5	---	---
		SPST-NO		V-154-3C5	V-104-3C5	---	---
SPDT		0.59N	---	V-104-1C4	---	V-104-1C4-T	
SPST-NC			---	V-104-2C4	---	---	
SPST-NO			---	V-104-3C4	---	---	
Short hinge roller lever 	Solder terminals (A)	SPDT	4.71N	V-155-1A6	---	V-155-1A6-T	---
		SPST-NC		V-155-2A6	---	---	---
		SPST-NO		V-155-3A6	---	---	---
		SPDT	2.35N	V-155-1A5	V-105-1A5	V-155-1A5-T	V-105-1A5-T
		SPST-NC		V-155-2A5	V-105-2A5	---	---
		SPST-NO		V-155-3A5	V-105-3A5	---	---
		SPDT	1.18N	---	V-105-1A4	---	V-105-1A4-T
		SPST-NC		---	V-105-2A4	---	---
		SPST-NO		---	V-105-3A4	---	---
	Quick-connect terminals (#187) (C2)	SPDT	4.71N	V-155-1C26	---	V-155-1C26-T	---
		SPST-NC		V-155-2C26	---	---	---
		SPST-NO		V-155-3C26	---	---	---
		SPDT	2.35N	V-155-1C25	V-105-1C25	V-155-1C25-T	V-105-1C25-T
		SPST-NC		V-155-2C25	V-105-2C25	---	---
		SPST-NO		V-155-3C25	V-105-3C25	---	---
		SPDT	1.18N	---	V-105-1C24	---	V-105-1C24-T
		SPST-NC		---	V-105-2C24	---	---
		SPST-NO		---	V-105-3C24	---	---
	Quick-connect terminals (#250) (C)	SPDT	4.71N	V-155-1C6	---	V-155-1C6-T	---
		SPST-NC		V-155-2C6	---	---	---
		SPST-NO		V-155-3C6	---	---	---
		SPDT	2.35N	V-155-1C5	V-105-1C5	V-155-1C5-T	V-105-1C5-T
		SPST-NC		V-155-2C5	V-105-2C5	---	---
		SPST-NO		V-155-3C5	V-105-3C5	---	---
SPDT		1.18N	---	V-105-1C4	---	V-105-1C4-T	
SPST-NC			---	V-105-2C4	---	---	
SPST-NO			---	V-105-3C4	---	---	

Refer to "Micro Switch Common Accessories" for Separators (sold separately), Actuators (sold separately) and Terminal Connectors (sold separately).



Actuator	Terminals	Contact form	Ratings Maximum operating force (OF)	15A	10A	Heat-resistive	
						15A	10A
Hinge roller lever 	Solder terminals (A)	SPDT	2.45N	V-156-1A6	---	V-156-1A6-T	---
		SPST-NC		V-156-2A6	---	---	---
		SPST-NO		V-156-3A6	---	---	
		SPDT	1.23N	V-156-1A5	V-106-1A5	V-156-1A5-T	V-106-1A5-T
		SPST-NC		V-156-2A5	V-106-2A5	---	---
		SPST-NO		V-156-3A5	V-106-3A5	---	---
		SPDT	0.59N	---	V-106-1A4	---	V-106-1A4-T
		SPST-NC		---	V-106-2A4	---	---
		SPST-NO		---	V-106-3A4	---	---
	Quick-connect terminals (#187) (C2)	SPDT	2.45N	V-156-1C26	---	V-156-1C26-T	---
		SPST-NC		V-156-2C26	---	---	---
		SPST-NO		V-156-3C26	---	---	
		SPDT	1.23N	V-156-1C25	V-106-1C25	V-156-1C25-T	V-106-1C25-T
		SPST-NC		V-156-2C25	V-106-2C25	---	---
		SPST-NO		V-156-3C25	V-106-3C25	---	---
		SPDT	0.59N	---	V-106-1C24	---	V-106-1C24-T
		SPST-NC		---	V-106-2C24	---	---
		SPST-NO		---	V-106-3C24	---	---
	Quick-connect terminals (#250) (C)	SPDT	2.45N	V-156-1C6	---	V-156-1C6-T	---
		SPST-NC		V-156-2C6	---	---	
		SPST-NO		V-156-3C6	---	---	
		SPDT	1.23N	V-156-1C5	V-106-1C5	V-156-1C5-T	V-106-1C5-T
		SPST-NC		V-156-2C5	V-106-2C5	---	---
		SPST-NO		V-156-3C5	V-106-3C5	---	---
		SPDT	0.59N	---	V-106-1C4	---	V-106-1C4-T
		SPST-NC		---	V-106-2C4	---	---
	SPST-NO	---		V-106-3C4	---	---	

## Contact form

SPDT

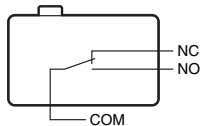

SPST-NC

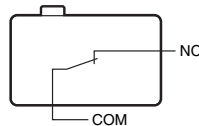

SPST-NO

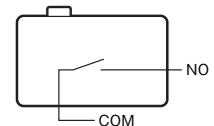

Refer to "**Micro Switch Common Accessories**" for Separators (sold separately), Actuators (sold separately) and Terminal Connectors (sold separately).

## Contact Specifications

Item	Model	V-21	V-16	V-15	V-10
Contact	Specification	Rivet			
	Material	Silver alloy			Silver
	Gap (standard value)	1 mm			
Inrush current	NC	50 A max.	40 A max.	30 A max.	24 A max.
	NO				
Minimum applicable load (reference value)		DC5V 160mA			

## Ratings

Model	Rated voltage	Item	Resistive load
V-21	AC250V		21 A
	DC125V		0.6 A
	DC250V		0.3 A
V-16	AC250V		16 A
	DC125V		0.6 A
	DC250V		0.3 A
V-15	AC250V		15 A
	DC125V		0.6 A
	DC250V		0.3 A
V-10	AC250V		10 A
	DC125V		0.6 A
	DC250V		0.3 A

Note. The above rating values apply under the following test conditions.

- (1) Ambient temperature: 20±2°C
- (2) Ambient humidity: 65±5% RH
- (3) Operating frequency: 30 operations/min

## Characteristics

Item	Model	V-10	V-15	V-16	V-21
Permissible operating speed		0.1mm to 1 m/s max. (pin plunger models)			
Permissible operating frequency	Mechanical	600 operations/min max. (pin plunger models)			
	Electrical	60 operations/min			
Insulation resistance		100MΩ min. (at 500 VDC with insulation tester)			
Contact resistance (initial value)		15mΩ max.			
Dielectric strength *1	Between terminals of the same polarity	AC1,000V 50/60Hz 1min			
	Between current-carrying metal parts and ground	AC1,500V 50/60Hz 1min	AC1,500V 50/60Hz 1min	AC2,000V 50/60Hz 1min	
	Between each terminals and non-current-carrying metal parts	AC1,500V 50/60Hz 1min	AC1,500V 50/60Hz 1min	AC2,000V 50/60Hz 1min	
Vibration resistance *2	Malfunction	10 to 55 Hz, 1.5-mm double amplitude			
Shock resistance *2	Durability	1,000 m/s <sup>2</sup> {approx. 100 G} max.			
	Malfunction	200 m/s <sup>2</sup> {approx. 20G} max.	300 m/s <sup>2</sup> {approx. 30 G} max.		
Durability *3	Mechanical	50,000,000 operations min. (60 operations/min)			
	Electrical	300,000 operations min. (30 operations/min) Heat resistive: 50,000 operations min (30 operations/min)	100,000 operations min. (30 operations/min) Heat resistive: 20,000 operations min (30 operations/min)	100,000 operations min. (30 operations/min)	
Degree of protection		IEC IP40			
Degree of protection against electric shock		Class I			
Proof tracking index (PTI)		175			
Ambient operating temperature		-25°C to +80°C (Heat resistive: -25°C to +150°C) (at ambient humidity of 60% max.) (with no icing or condensation)			
Ambient operating humidity		85% max. (for +5°C to +35°C)			
Weight		Approx. 6.2g (pin plunger models)			

Note. The data given above are initial values.

- \*1. The dielectric strength shown in the table indicates a value for models with a Separator.
- \*2. For the pin plunger models, the above values apply for use at the free position and total travel position. For the lever models, they apply at the total travel position. Close or open circuit of the contact is shorter than 1 ms.
- \*3. For testing conditions, consult your OMRON sales representative.

## Approved Standards

### UL (UL1054)/CSA (CSA C22.2 No.55)

Rated voltage	Model	V-21	V-16	V-15	V-10
125 VAC		21A 1/2HP	16A 1/2HP	15A 1/2HP	10A 1/2HP
250 VAC					
125 VDC		0.6A			
250 VDC		0.3A			

### VDE (EN61058-1)

Consult your OMRON sales representative for specific models with VDE approvals.

Rated voltage	Model	V-21	V-16
AC250V		20(4)A	16(4)A

Testing conditions: 5E4 (50,000 operations), for models of V-21: T80 (0°C to 80°C), for models of V-16: T105 (0°C to 105°C)

**Terminals and Appearance (Unit: mm)**

Solder terminals (A)	Quick-connect terminals (#187) (C2)	Quick-connect terminals (#250) (C)
<p>Three, solder terminals</p>	<p>Three, quick-connect terminals (#187)</p>	<p>Three, quick-connect terminals (#250)</p>
<p>* Indicates the length to the center of the 1.6-dia. holes</p>	<p>1.6-dia. terminal hole</p>	<p>1.65-dia. terminal hole</p>

Note. The above is for the SPDT contact specifications. Two terminals will be available for SPST-NO or SPST-NC contact specifications. For terminal positions, refer to Contact form on page 9.

**Mounting Holes (Unit: mm)**

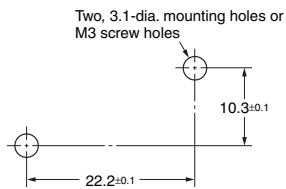

## Dimensions and Operating Characteristics

### Thermoplastic Case V-21/-16 Models

The following illustrations and drawings are for COM bottom position and quick-connect terminals #250 (terminals C). V models with a switching current of 16 A and 11 A incorporate solder terminals (A) and quick-connect terminals #187 (C2). These models are different from #250 models in terminal size only. Dimensions of solder terminals A, quick-connect terminal #187 (C2) and COM side position are omitted. Please refer to the "Terminals and Shapes" on previous page.

The □ is replaced with the code for the terminals. See the "List of Models" for available combinations of shapes.

#### ●Pin plunger

V-21-1□6

V-16-1□6

V-16-1□5

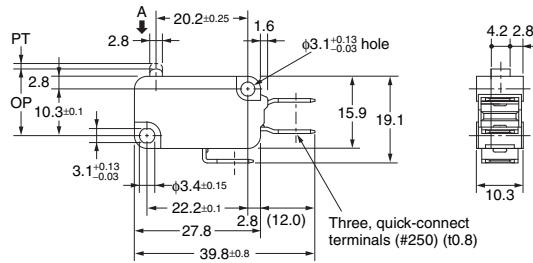

Operating characteristics	Model	V-21-1□6 V-16-1□6	V-16-1□5
OF max.		3.92N	1.96N
RF min.		0.78N	0.49N
PT max.		1.2mm	
OT min.		1.0mm	
MD max.		0.4mm	
OP		14.7±0.4mm	

#### ●Short hinge lever

V-211-1□6

V-161-1□6

V-161-1□5

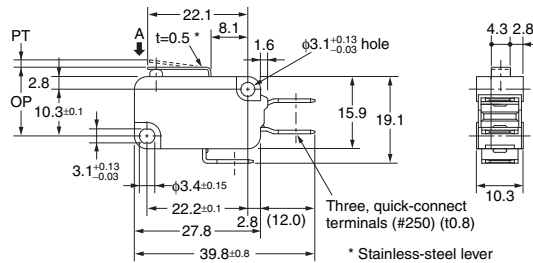
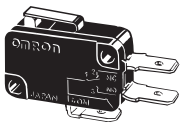

Operating characteristics	Model	V-211-1□6 V-161-1□6	V-161-1□5
OF max.		3.92N	1.96N
RF min.		0.49N	0.49N
PT max.		1.6mm	
OT min.		0.8mm	
MD max.		0.6mm	
OP		15.2±0.5mm	

#### ●Hinge lever

V-212-1□6

V-162-1□6

V-162-1□5

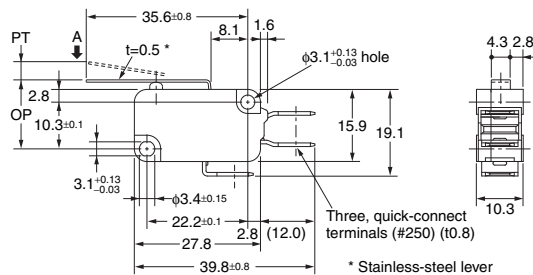
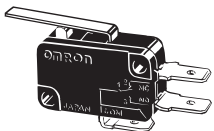

Operating characteristics	Model	V-212-1□6 V-162-1□6	V-162-1□5
OF max.		2.45N	1.23N
RF min.		0.25N	0.14N
PT max.		4.0mm	
OT min.		1.6mm	
MD max.		1.5mm	
OP		15.2±1.2mm	

#### ●Long Hinge Lever Models

V-213-1□6

V-163-1□6

V-163-1□5

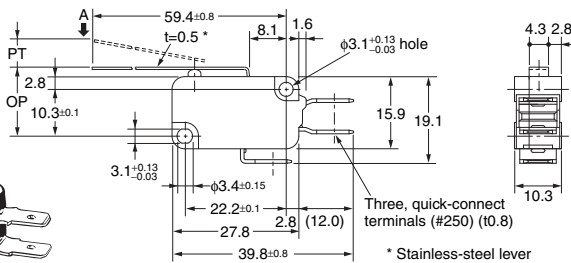
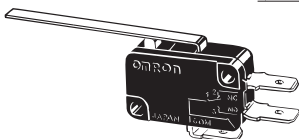

Operating characteristics	Model	V-213-1□6 V-163-1□6	V-163-1□5
OF max.		1.27N	0.69N
RF min.		0.12N	0.06N
PT max.		9.0mm	
OT min.		2.0mm	
MD max.		2.8mm	
OP		15.2 <sup>+2.6</sup> / <sub>-3.2</sub> mm	

Note 1. Unless otherwise specified, a tolerance of ±0.4 mm applies to all dimensions.

Note 2. The operating characteristics are for operation in the A direction (↓).

● Simulated roller lever

V-214-1□6

V-164-1□6

V-164-1□5

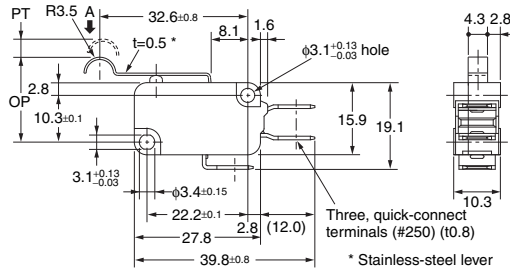
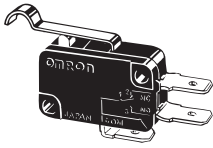

Operating characteristics	Model	V-214-1□6	V-164-1□5
		V-164-1□6	
OF max.		2.45N	1.23N
RF min.		0.25N	0.14N
PT max.		4.0mm	
OT min.		1.6mm	
MD max.		1.5mm	
OP		18.7±1.2mm	

● Short hinge roller lever

V-215-1□6

V-165-1□6

V-165-1□5

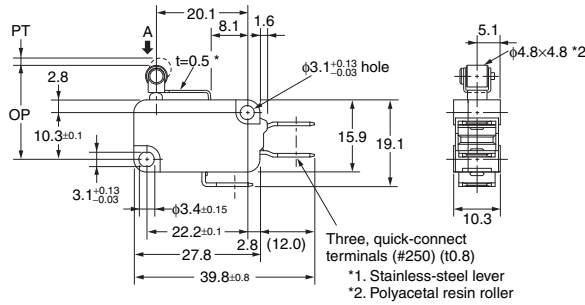
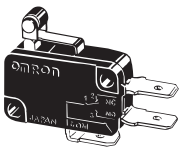

Operating characteristics	Model	V-215-1□6	V-165-1□5
		V-165-1□6	
OF max.		4.71N	2.35N
RF min.		0.49N	0.49N
PT max.		1.6mm	
OT min.		0.8mm	
MD max.		0.6mm	
OP		20.7±0.6mm	

● Hinge roller lever

V-216-1□6

V-166-1□6

V-166-1□5

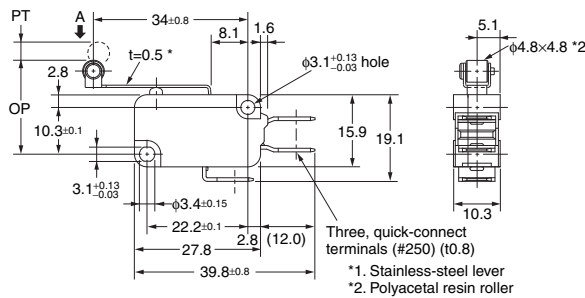
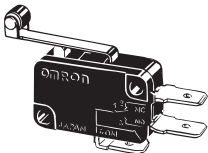

Operating characteristics	Model	V-216-1□6	V-166-1□5
		V-166-1□6	
OF max.		2.45N	1.23N
RF min.		0.25N	0.14N
PT max.		4.0mm	
OT min.		1.6mm	
MD max.		1.5mm	
OP		20.7±1.2mm	

Note 1. Unless otherwise specified, a tolerance of ±0.4 mm applies to all dimensions.

Note 2. The operating characteristics are for operation in the A direction (↓).

## Thermosetting Case (V-15/V-10 Models) Applicable to both Standard (80°C) and Heat-resistant (150°C) models

The following dimensions and Operating Characteristics are for both "Not specified: Standard (80°C)" and "-T: Heat-resistant (150°C)" models. The following illustrations and drawings are for COM bottom position and solder terminals (Terminal A). V models with a switching current of 15A and 10A have screw terminals (B) and quick-connect terminals #187 (C2). These models are different from #250 models in terminal size only. Illustrations for screw terminals (B) and quick-connect terminals #187 (C2) are omitted. Please refer to "Terminals and Shapes" on page 8.

The □ is replaced with the code for the terminals. See the "List of Models" for available combinations of shapes.

### ●Pin plunger

- V-15-1□6
- V-15-1□5
- V-10-1□5
- V-10-1□4

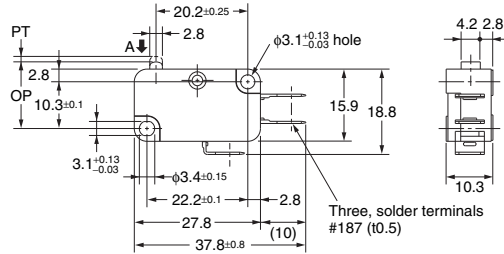
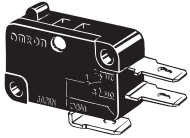

Operating characteristics	Model	V-15-1□6	V-15-1□5 V-10-1□5	V-10-1□4
OF max.		3.92N	1.96N	0.98N
RF min.		078N	0.49N	0.20N
PT max.		1.2mm		
OT min.		1.0mm		
MD max.		0.4mm		
OP		14.7±0.4mm		

### ●Short hinge lever

- V-151-1□6
- V-151-1□5
- V-101-1□5
- V-101-1□4

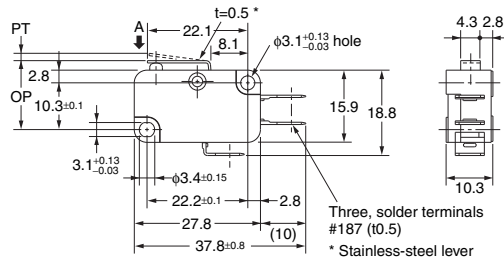
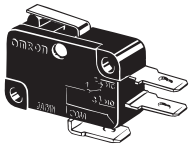

Operating characteristics	Model	V-151-1□6	V-151-1□5 V-101-1□5	V-101-1□4
OF max.		3.92N	1.96N	0.98N
RF min.		0.49N	0.49N	0.15N
PT max.		1.6mm		
OT min.		0.8mm		
MD max.		0.6mm		
OP		15.2±0.5mm		

### ●Hinge lever

- V-152-1□6
- V-152-1□5
- V-102-1□5
- V-102-1□4

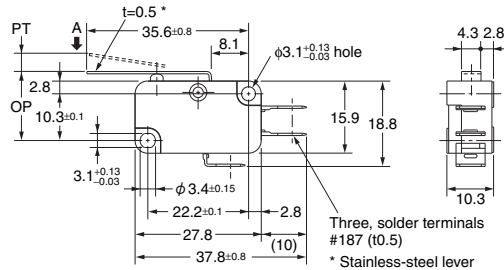
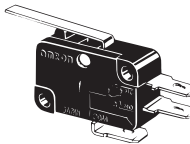

Operating characteristics	Model	V-152-1□6	V-152-1□5 V-102-1□5	V-102-1□4
OF max.		2.45N	1.23N	0.59N
RF min.		0.25N	0.14N	0.06N
PT max.		4.0mm		
OT min.		1.6mm		
MD max.		1.5mm		
OP		15.2±1.2mm		

### ●Long Hinge Lever Models

- V-153-1□6
- V-153-1□5
- V-103-1□5
- V-103-1□4

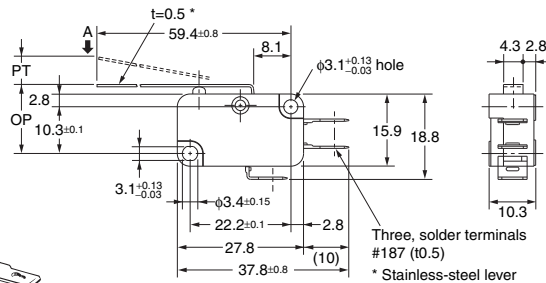
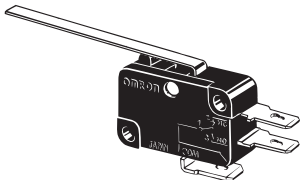

Operating characteristics	Model	V-153-1□6	V-153-1□5 V-103-1□5	V-103-1□4
OF max.		1.27N	0.69N	0.34N
RF min.		0.12N	0.06N	-
PT max.		9.0mm		
OT min.		2.0mm		
MD max.		2.8mm		
OP		15.2 <sup>+2.6</sup> / <sub>-3.2</sub> mm		15.2±2.6 mm

Note 1. Unless otherwise specified, a tolerance of ±0.4 mm applies to all dimensions.

Note 2. The operating characteristics are for operation in the A direction (↓).

● Simulated roller lever

- V-154-1□6
- V-154-1□5
- V-104-1□5
- V-104-1□4

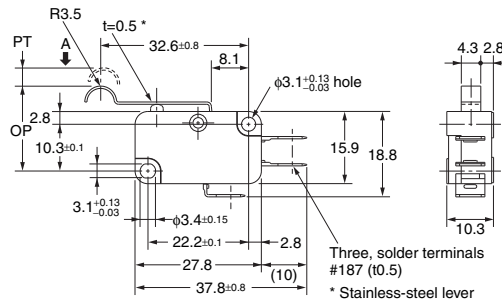
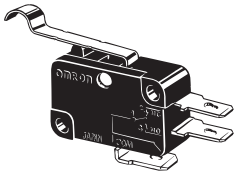

Operating characteristics	Model	V-154-1□6	V-154-1□5 V-104-1□5	V-104-1□4
OF max.		2.45N	1.23N	0.59N
RF min.		0.25N	0.14N	0.06N
PT max.		4.0mm		
OT min.		1.6mm		
MD max.		1.5mm		
OP		18.7±1.2mm		

● Short hinge roller lever

- V-155-1□6
- V-155-1□5
- V-105-1□5
- V-105-1□4

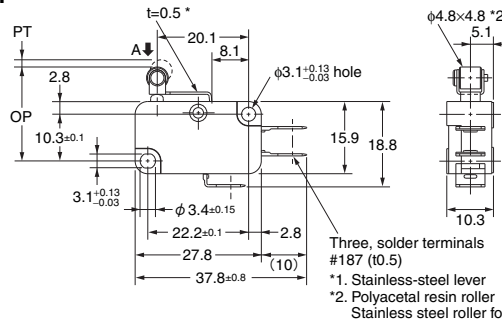
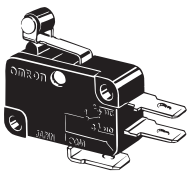

Operating characteristics	Model	V-155-1□6	V-155-1□5 V-105-1□5	V-105-1□4
OF max.		4.71N	2.35N	1.18N
RF min.		0.49N	0.49N	0.15N
PT max.		1.6mm		
OT min.		0.8mm		
MD max.		0.6mm		
OP		20.7±0.6mm		

● Hinge roller lever

- V-156-1□6
- V-156-1□5
- V-106-1□5
- V-106-1□4

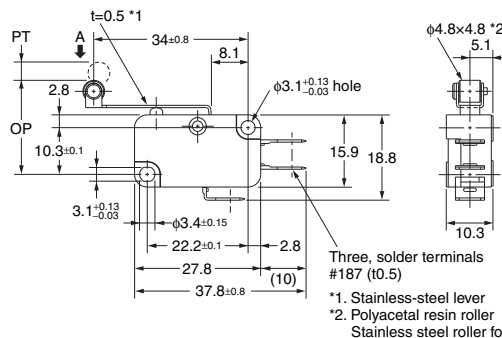
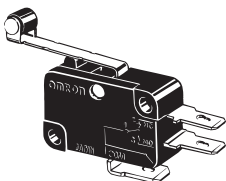

Operating characteristics	Model	V-156-1□6	V-156-1□5 V-106-1□5	V-106-1□4
OF max.		2.45N	1.23N	0.59N
RF min.		0.25N	0.14N	0.06N
PT max.		4.0mm		
OT min.		1.6mm		
MD max.		1.5mm		
OP		20.7±1.2mm		

Note 1. Unless otherwise specified, a tolerance of ±0.4 mm applies to all dimensions.  
 Note 2. The operating characteristics are for operation in the A direction (↓).

Precautions

★ Please read "Common Precautions" for correct use.

Precautions for Safe Use

● Soldering

- Connecting to Solder Terminals  
 Complete the soldering at the iron tip temperature of 250°C to 350°C (60W) within 5 seconds, and do not apply any external force for 1 minute after soldering.  
 Be sure to apply only the minimum required amount of flux. It may result in contact failure once the flux penetrates into the internal part of the Switch.
- Connecting to Quick-connect Terminals #187  
 Insert the receptacle of quick-connect terminal #187 straight toward the terminal.  
 Applying excessive external force horizontally or vertically may cause deformation of terminals and may damage the housings.
- Connecting to Quick-connect Terminals #250  
 Insert the receptacle of quick-connect terminal #250 straight toward the terminal.  
 Applying excessive external force horizontally or vertically may cause deformation of terminals and may damage the housings.

Precautions for Correct Use

● Mounting

Use M3 mounting screw with plane washers or spring washers to securely mount the Switch. Tighten the screws to a torque of 0.39 to 0.59N·m {4 to 6 kgf·cm}.

- Application examples provided in this document are for reference only. In actual applications, confirm equipment functions and safety before using the product.
- Consult your OMRON representative before using the product under conditions which are not described in the manual or applying the product to nuclear control systems, railroad systems, aviation systems, vehicles, combustion systems, medical equipment, amusement machines, safety equipment, and other systems or equipment that may have a serious influence on lives and property if used improperly. Make sure that the ratings and performance characteristics of the product provide a margin of safety for the system or equipment, and be sure to provide the system or equipment with double safety mechanisms.

**Note: Do not use this document to operate the Unit.**

---

**OMRON Corporation**

**ELECTRONIC AND MECHANICAL COMPONENTS COMPANY**

**Contact: [www.omron.com/ecb](http://www.omron.com/ecb)**

**Cat. No. B010-E1-12**  
0812(0207)(O)